

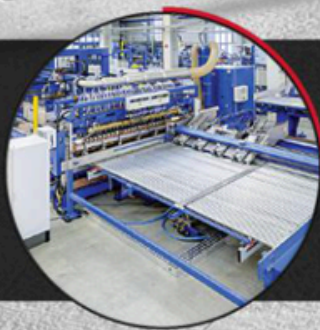

**ASGFENCE**



**Safe Spaces Surrounded by Quality**



**Safe Spaces Surrounded by Quality**

- Since 1985, our company has been dedicated to serving its valued clients from a 15,000-square-meter indoor, state-of-the-art facility equipped with advanced machinery and modern technology. With a monthly production capacity of 3,000 tons, we utilize industry-leading equipment, including EVG, Ideal, Wagner, and Wafios machine lines, to ensure the highest quality standards in our products.

Since the inauguration of our new factory in 2010, we have set industry standards in high-quality panel fence production, bringing a fresh approach to the sector and solidifying our position as a leader.

Our team of experienced administrative and technical professionals, combined with our high-standard manufacturing facility, produces advanced wire fencing systems that support the national economy. Our diverse product portfolio includes panel fences and high-security fences solutions meticulously designed to withstand all weather conditions, resist corrosion, and ensure durability while being environmentally friendly.

Customer satisfaction is our foremost principle, and we offer products in customized colors and dimensions tailored to individual needs. Our ongoing R&D initiatives enable us to continually expand our product range, introducing innovative items to meet the evolving demands of the industry.

We are honored to maintain a strong presence in Germany, the United Kingdom, France, the Balkans, and over 70 regions worldwide, with a substantial market share. Additionally, we operate a 2,500-square-meter retail warehouse in Stuttgart, Germany, to better serve our European clients.

Through our registered brands Dh Zaunsysteme GmbH, Dh Fence Systems UK, and Dh Cloture we proudly represent our country on an international stage, delivering projects that bear the distinguished “ASG FENCE” signature.



**Safe Spaces Surrounded by Quality**

# ASG V-MESH ECO / MEDIUM



"ASG V-Mesh Eco/Medium " is a modern fence system that stands out with its unique design and functionality. The characteristic V-shaped bends not only offer an attractive appearance but also provide additional stability and durability.

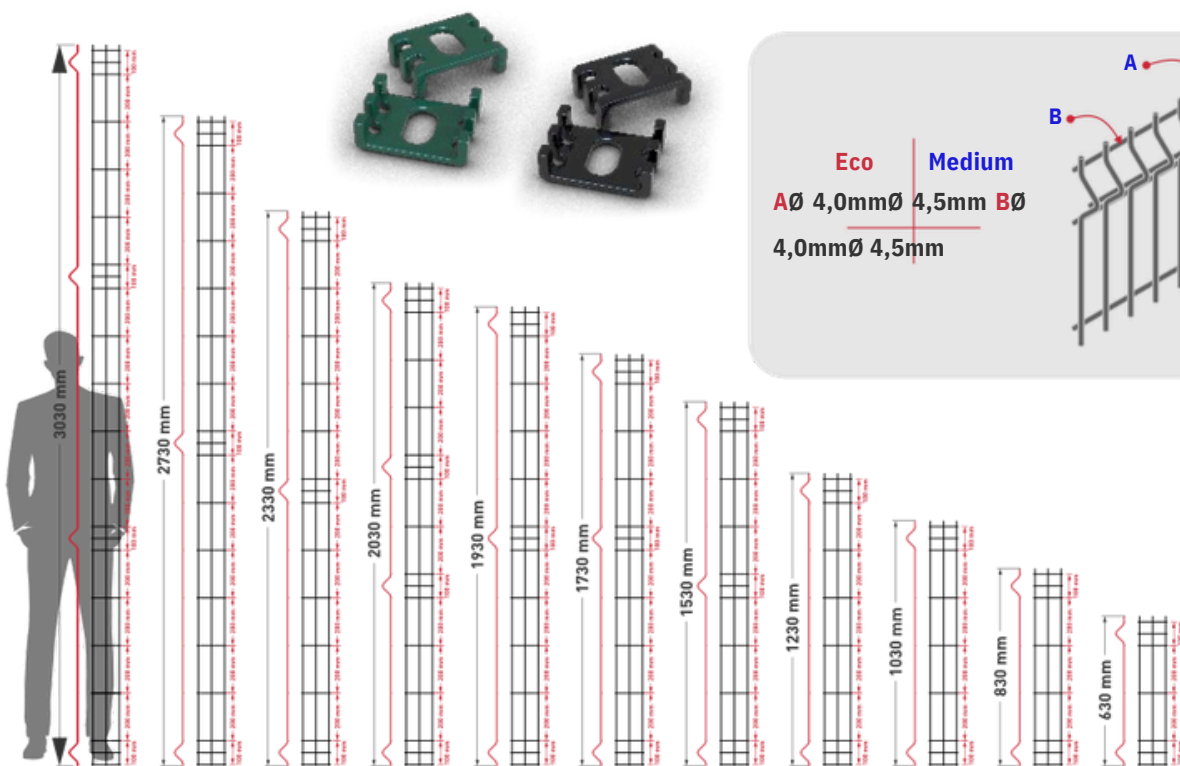

**Eco Medium**  
**A Ø 4,0mm Ø 4,5mm B Ø 4,0mm Ø 4,5mm**

**Coating Details**

**Color Options**

Wire	Ø 4,0*4,0 mm / 4,5*4,5 mm	Height	630/ ..... / 3030 mm
Mesh Size	50 mm / 200 mm	Width	3000 mm

**Safe Spaces Surrounded by Quality**



**Safe Spaces Surrounded by Quality**

# ASG V-MESH HYBRIDE / PRO

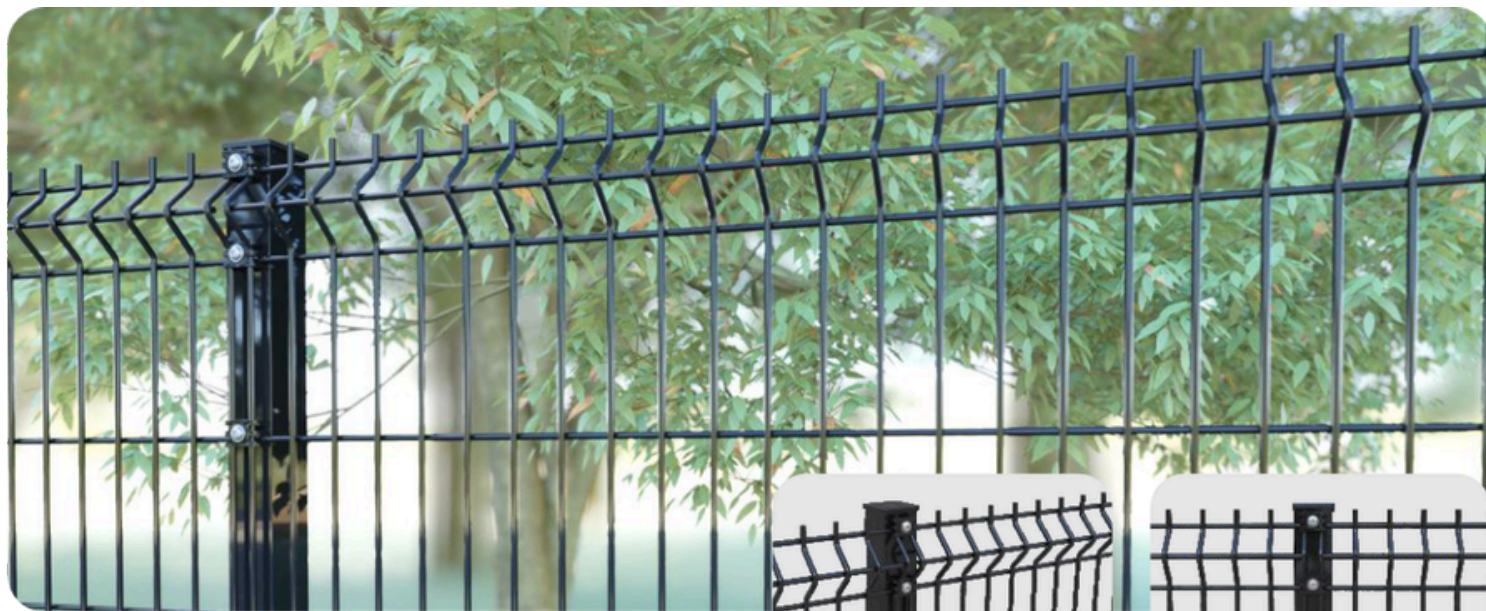

"ASG V-Mesh HYBRIDE/PRO " is a modern fence system that stands out with its unique design and functionality. The characteristic V-shaped bends not only offer an attractive appearance but also provide additional stability and durability.

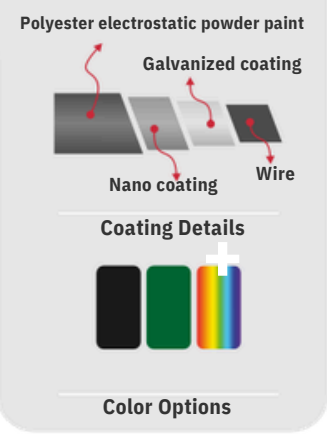
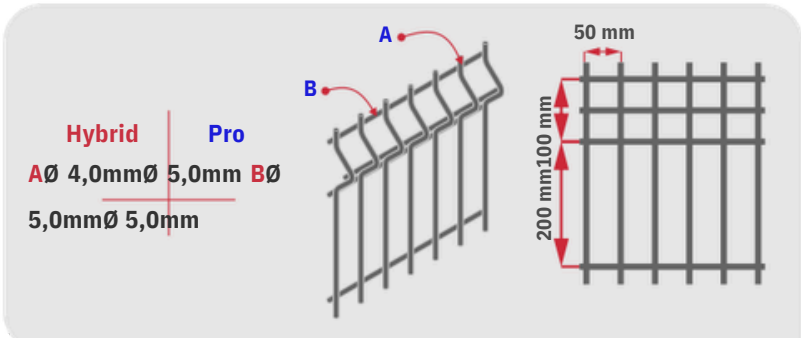
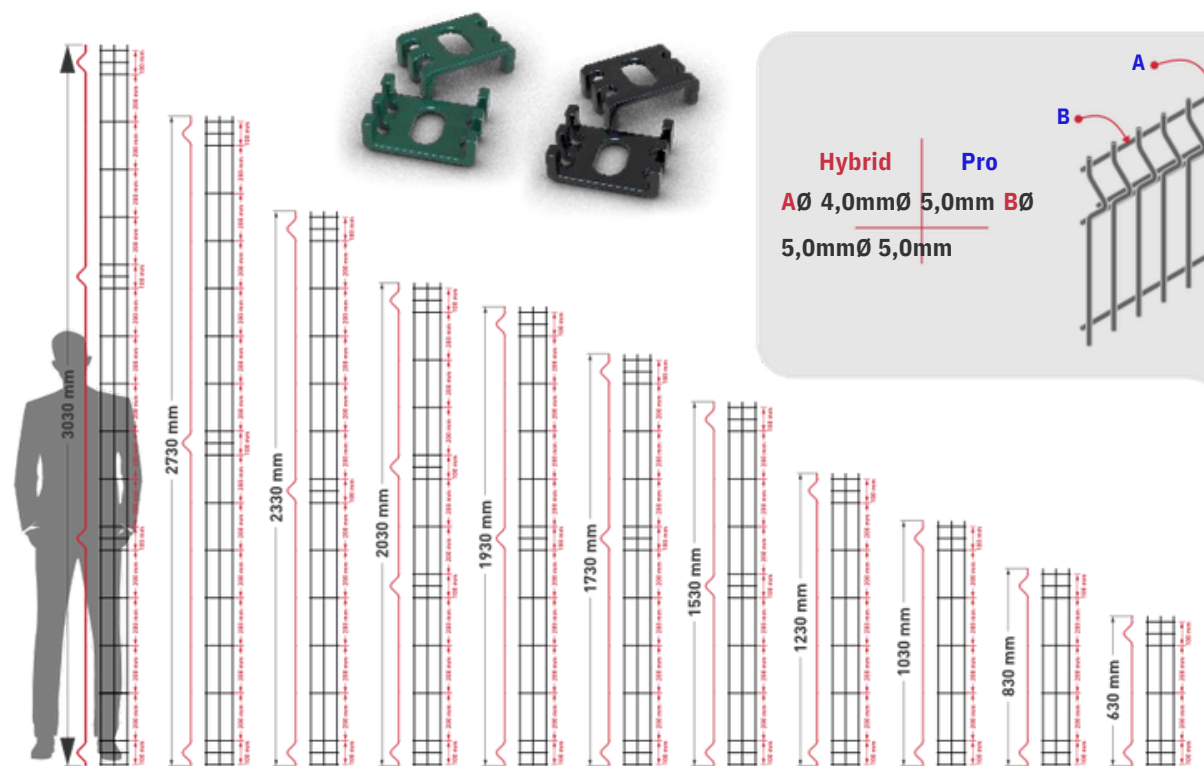

Wire	Ø 4,0*5,0 mm / 5,0*5,0 mm	Height	630/ ..... / 3030 mm
Mesh Size	50 mm / 200 mm	Width	3000 mm

**Safe Spaces Surrounded by Quality**



**Safe Spaces Surrounded by Quality**

# ASG TWIN WIRE



As the name suggests, "**ASG Twin Wire Panel**" stands out with its dual-panel construction. Thanks to high-quality welded joints and double horizontal wires, this fence system offers exceptional impact resistance and superior durability.

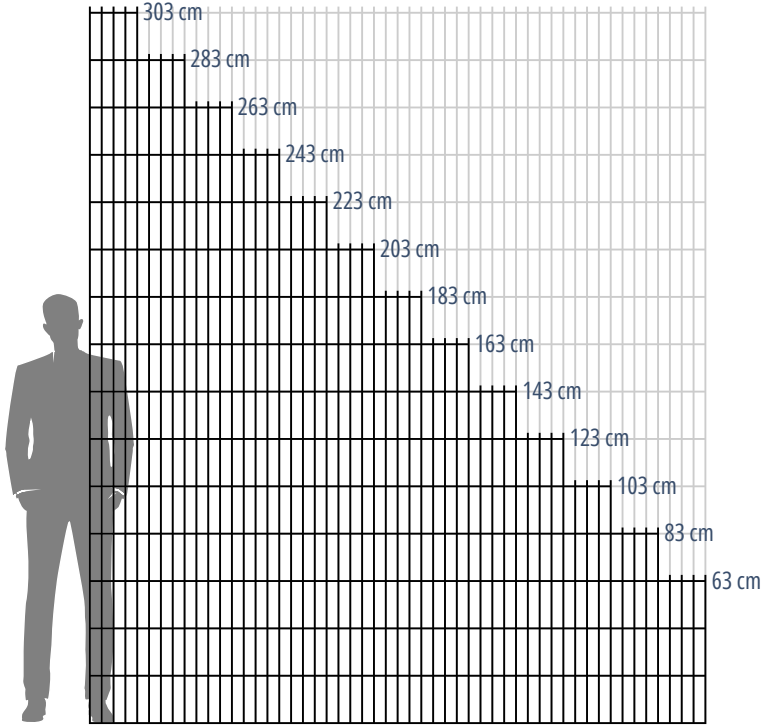

Ø 5mm

Ø 6mm

50 mm

200 mm

**Coating Details**

**Color Options**

Wire	Ø 6*5*6 mm	Height	630/ ..... / 3030 mm
Mesh Size	50 mm / 200 mm	Width	2000 / 2500 / 3000 mm

**Safe Spaces Surrounded by Quality**



**Safe Spaces Surrounded by Quality**

# ASG TWIN WIRE PRO



As the name suggests, "**ASG Twin Wire Pro**" stands out with its dual-panel construction. Thanks to high-quality welded joints and double horizontal wires, this fence system offers exceptional impact resistance and superior durability.

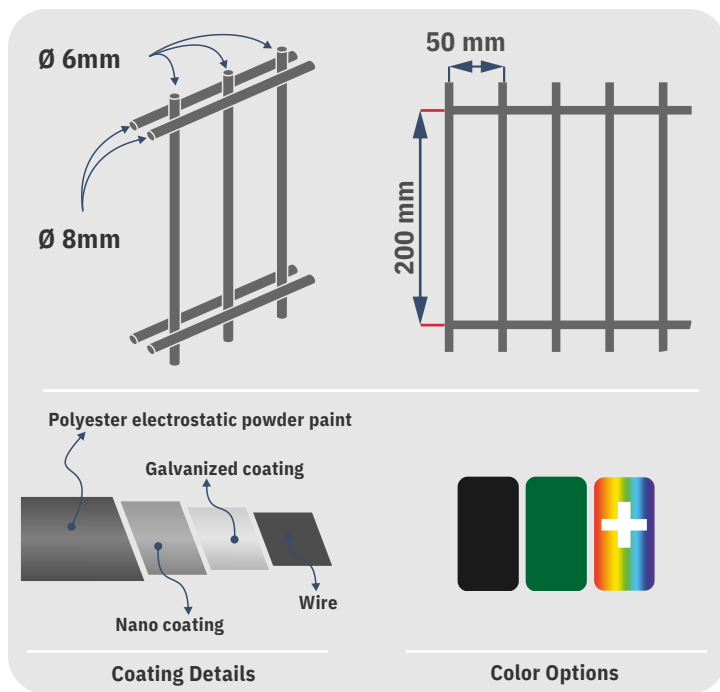
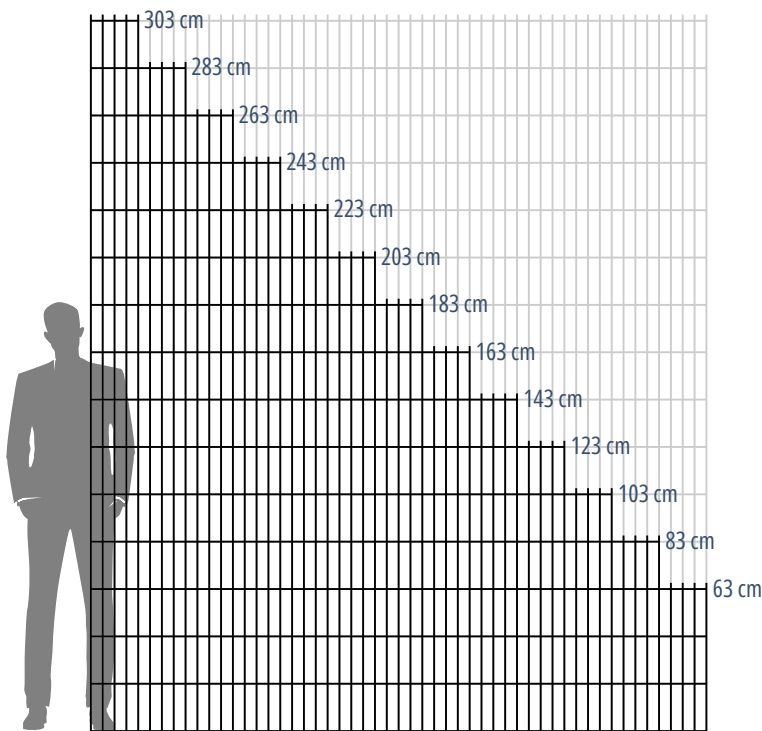

Wire	<b>8*6*8 mm</b>	Height	<b>630/ ..... / 3030 mm</b>
Mesh Size	<b>50 mm / 200 mm</b>	Width	<b>2000 / 2500 / 3000 mm</b>

**Safe Spaces Surrounded by Quality**



**Safe Spaces Surrounded by Quality**

# ASG DOUBLE SPORT



As the name suggests, "**ASG Twin Wire Pro**" stands out with its dual-panel construction. Thanks to high-quality welded joints and double horizontal wires, this fence system offers exceptional impact resistance and superior durability.

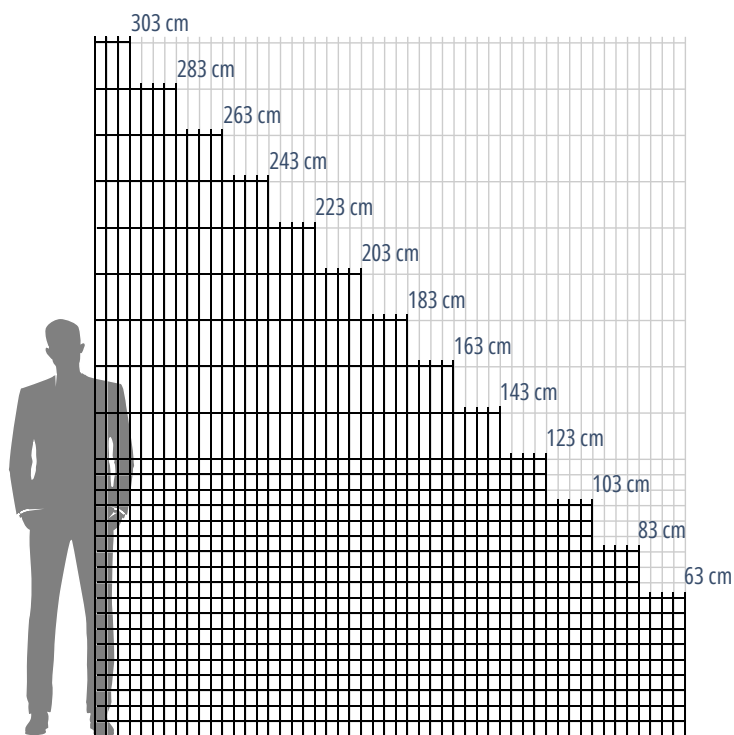
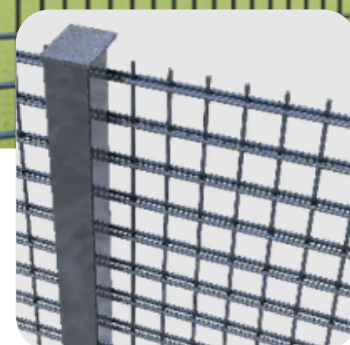
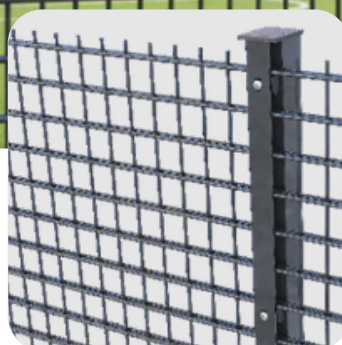

Ø 6mm

Ø 8mm

50 mm

66.7 mm/200 mm

Above 1200 mm, the mesh size is 66.7 mm and continues as 200 mm.

**Coating Details**

Nano coating

Galvanized coating

Polyester electrostatic powder paint

Wire

**Color Options**

Wire	<b>8*6*8 mm</b>	Height	<b>630/ ..... / 3030 mm</b>
Mesh Size	<b>50 mm / 66.7 mm</b>	Width	<b>2000 / 2500 / 3000 mm</b>

## Safe Spaces Surrounded by Quality



**Safe Spaces Surrounded by Quality**

# ASG SECUREMESH 50

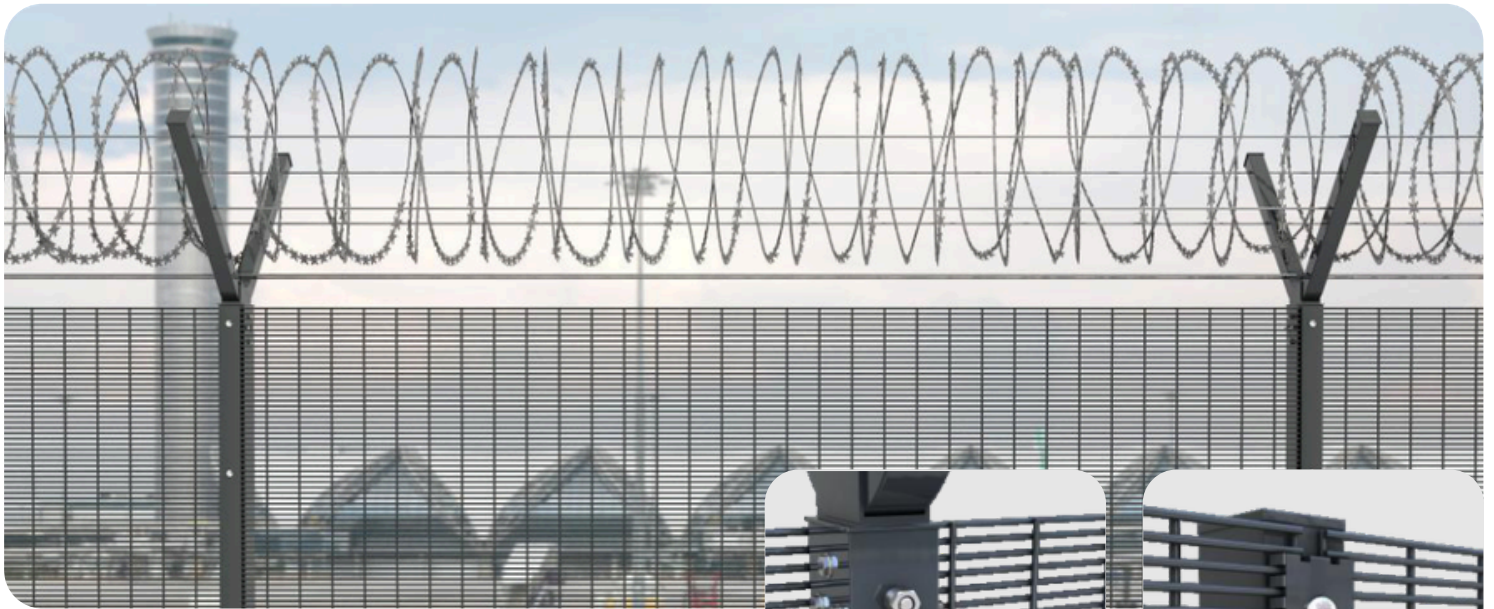

The "ASG SecureMesh 50" is a fence system specifically developed for areas requiring the highest level of security, such as military facilities, airports, power plants, and correctional institutions. Its robust construction, combined with additional deterrents such as barbed wire, makes climbing, cutting, or breaching significantly more difficult.

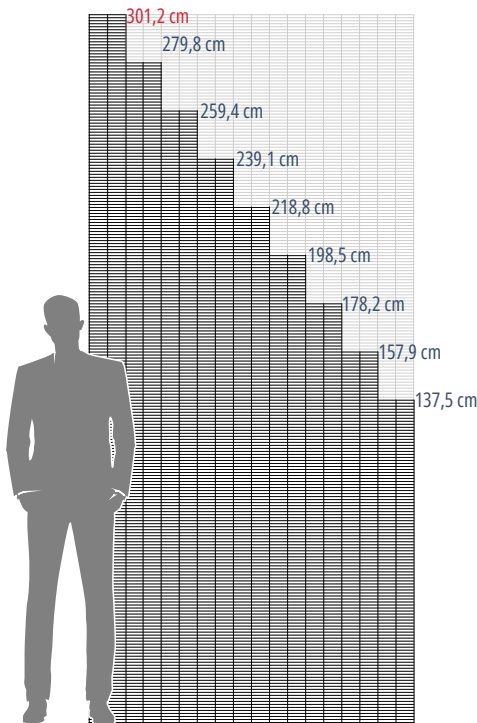

**4 mm** (wire thickness)

**12,7 mm** (mesh height)

**76,2 / 50 mm** (mesh width)

**Coating Details:** Polyester electrostatic powder paint, Galvanized coating, Nano coating, Wire.

**Color Options:** Black, Green, Rainbow, White (+).

Wire	Ø 4*4 mm	Height	1375/ ..... / 3012 mm
Mesh Size	12.7 mm / 76.2 - 50 mm	Width	2000 / 2500 / 3000 mm

**Safe Spaces Surrounded by Quality**



**Safe Spaces Surrounded by Quality**

# ASG SECUREMESH 10-4



The "ASG SecureMesh 10-4" is a fence system specifically developed for areas requiring the highest level of security, such as military facilities, airports, power plants, and correctional institutions. Its robust construction, combined with additional deterrents such as barbed wire, makes climbing, cutting, or breaching significantly more difficult.

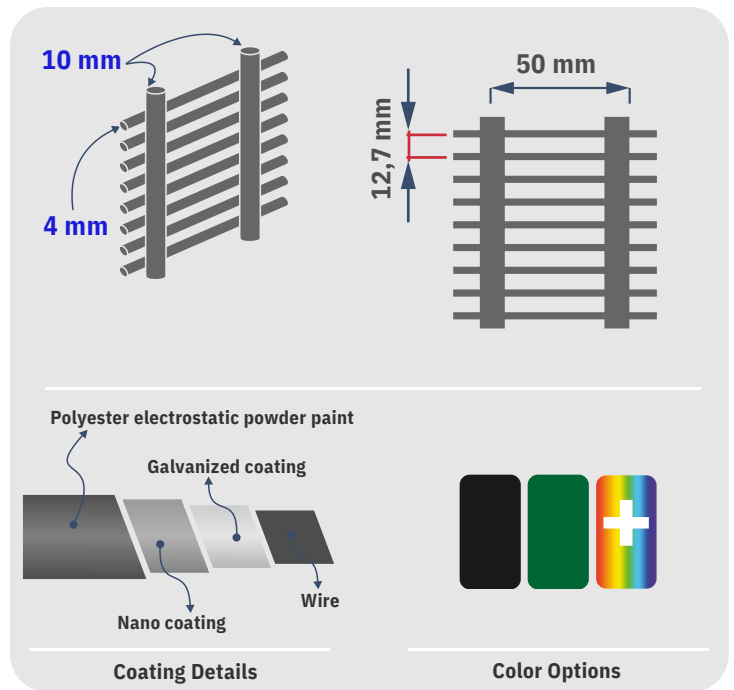
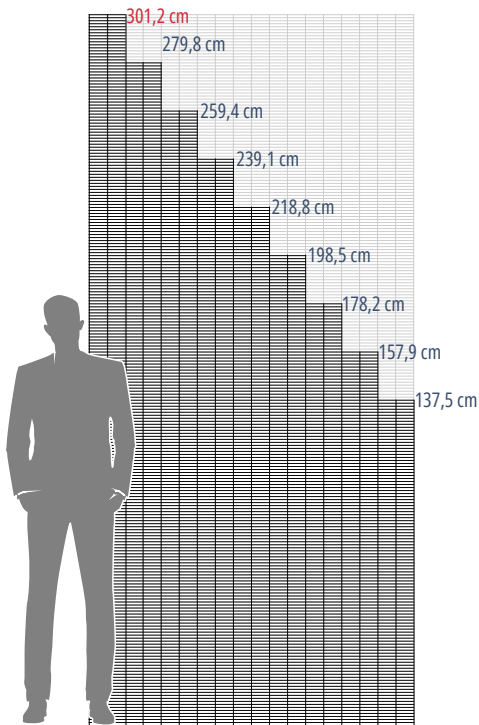
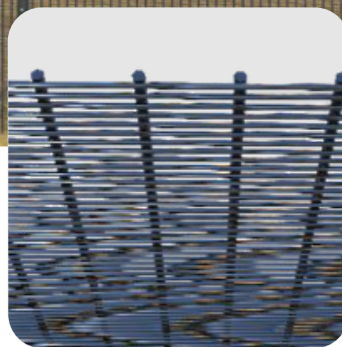

Wire	Ø 4*10 mm	Height	1375/ ..... / 3012 mm
Mesh Size	12.7 mm / 50 mm	Width	2000 / 2500 / 3000 mm

**Safe Spaces Surrounded by Quality**



**Safe Spaces Surrounded by Quality**

# ASG WELDED MESH FENCING



The **ASG Welded Mesh** is a fencing solution designed for agricultural areas, livestock enclosures, and rural boundaries. Its practical design provides secure containment while allowing clear visibility, making it ideal for protecting crops and animals. The durable, galvanized steel structure ensures long-lasting performance even in harsh outdoor conditions.

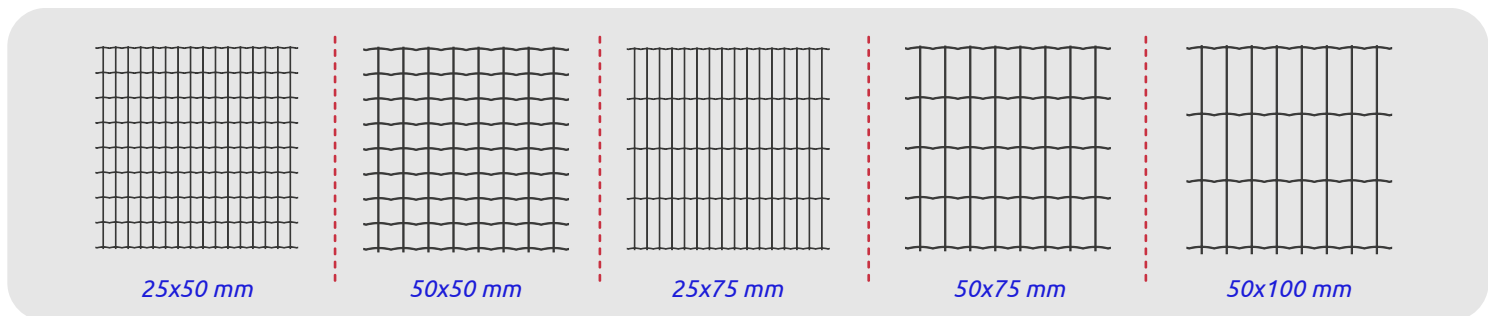
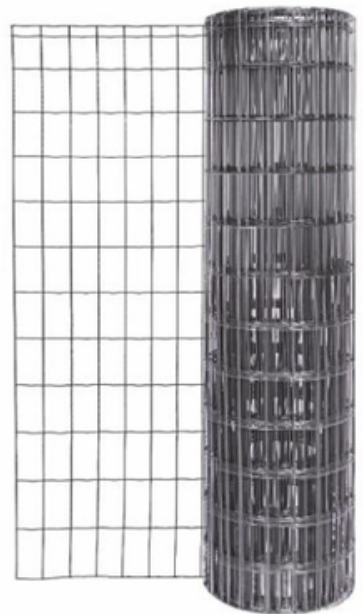
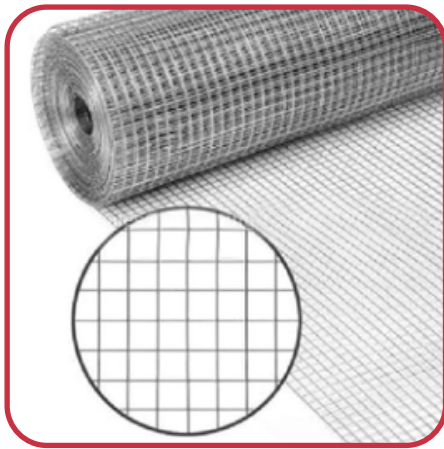

Wire	Ø 1,6.....3,0 mm	Height	1000/ 1250 / 1500 / 2000 mm	Width	25 m
Mesh Size	25*50 / 50*50 / 25*75 50*75 / 50*100 mm		Coating	Galvanized	

**Safe Spaces Surrounded by Quality**



**Safe Spaces Surrounded by Quality**

# ASG RECTANGULAR POST

The "ASG RectangularPost" provides maximum load capacity and stability for fence systems in demanding environments. Equipped with a flat bar and a sleek stainless steel cap, these posts combine functionality with a modern and aesthetic design. The galvanized coating and aluminum cap offer superior protection against corrosion and external elements. It is an ideal solution for industrial, commercial, and private applications.

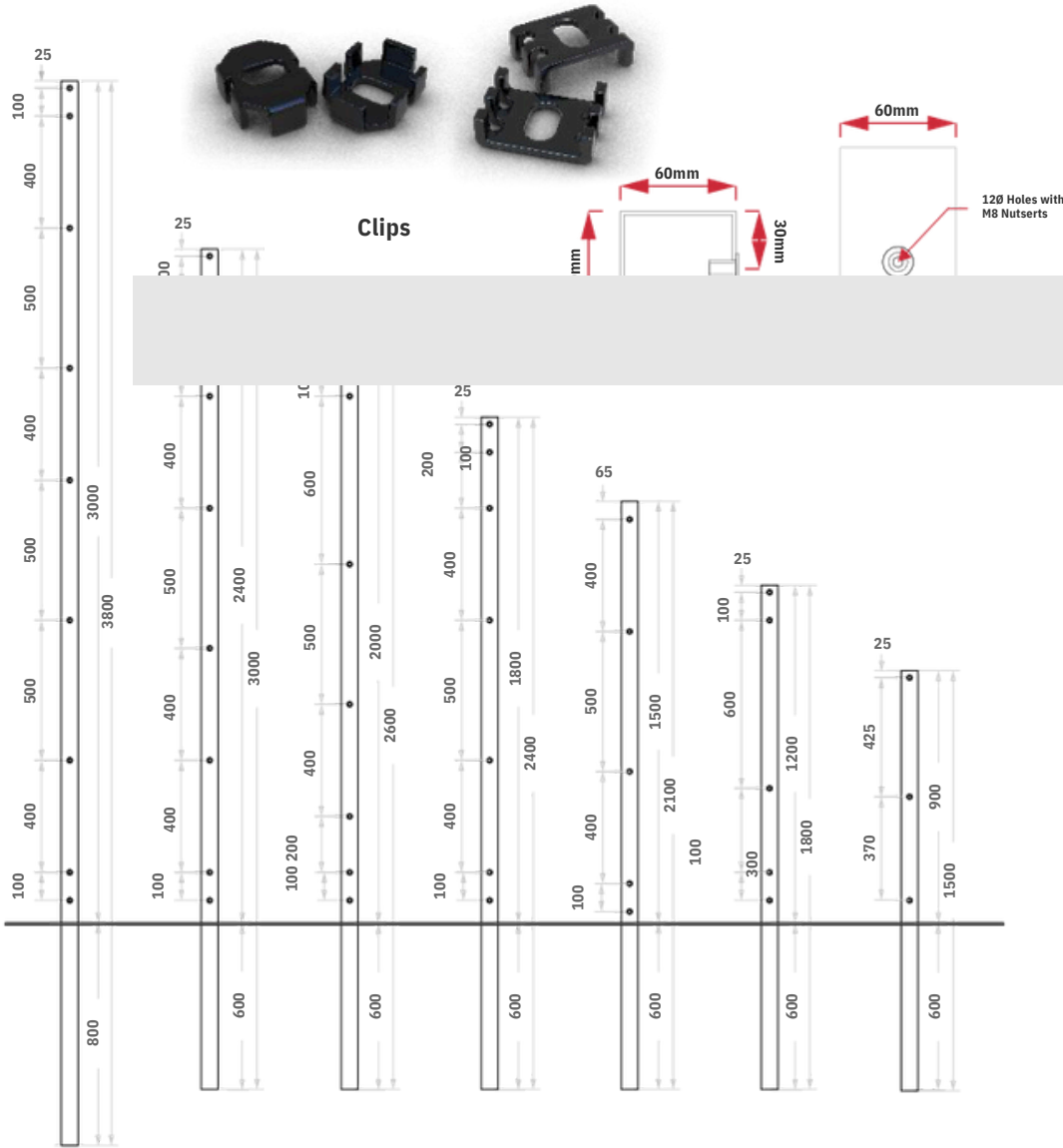

**Coating Details**

Metal  
Nano coating  
Galvanized coating  
Polyester electrostatic powder paint

**Color Options**

Height	40*60*1,5 mm / 40*60*2,0 mm	Post Height	1000 / ..... / 3700 mm
Cover Plate	40*4 mm	Panel Height	630 / ..... / 3030 mm

**Safe Spaces Surrounded by Quality**



**Safe Spaces Surrounded by Quality**

# ASG BAMBOO FENCE STANDARD

The “ASG Bamboo Fence Standard” offers the perfect combination of security, durability, and modern design. With a width of 2405 mm and various height options, it is highly versatile ideal for private properties, as well as commercial and industrial applications. By combining high security with elegant aesthetics, it stands out as the optimal choice for environments that demand both protection and sophisticated design.

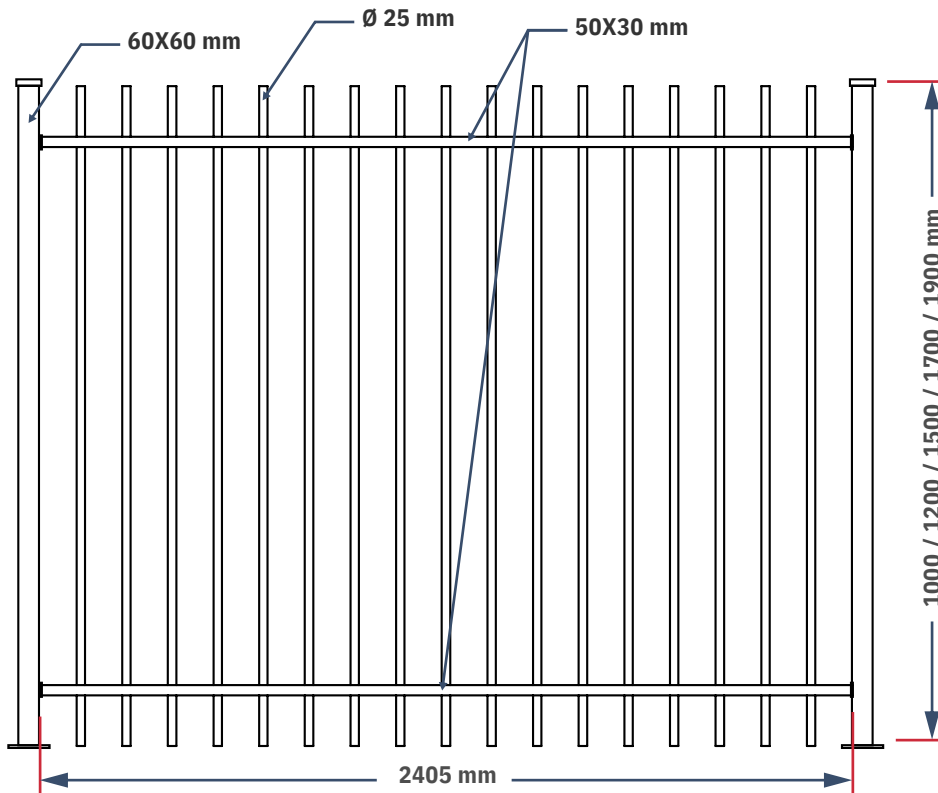

Height	1000 / 1200 / 1500 / 1700 / 1900
Width	mm 2405 mm
Top Rail	50 X 30 mm
Bottom Rail	50 X 30 mm
Vertical Bars	Ø 25 mm
Post	60 X 60 mm
Coating	Laminated on galvanized steel

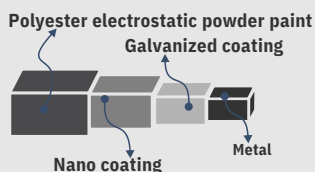

Coating Details

Color Options

**Safe Spaces Surrounded by Quality**



**Safe Spaces Surrounded by Quality**

# ASG BAMBOO FENCE TWIN

The “ASG Bamboo Fence Twin” is a benchmark product, renowned for its architectural and design excellence. With its clean lines, it offers a modern, industrial, and refined aesthetic. The metal rods enhance the structure with strength, precision, and character, while also reflecting key elements of contemporary architecture.

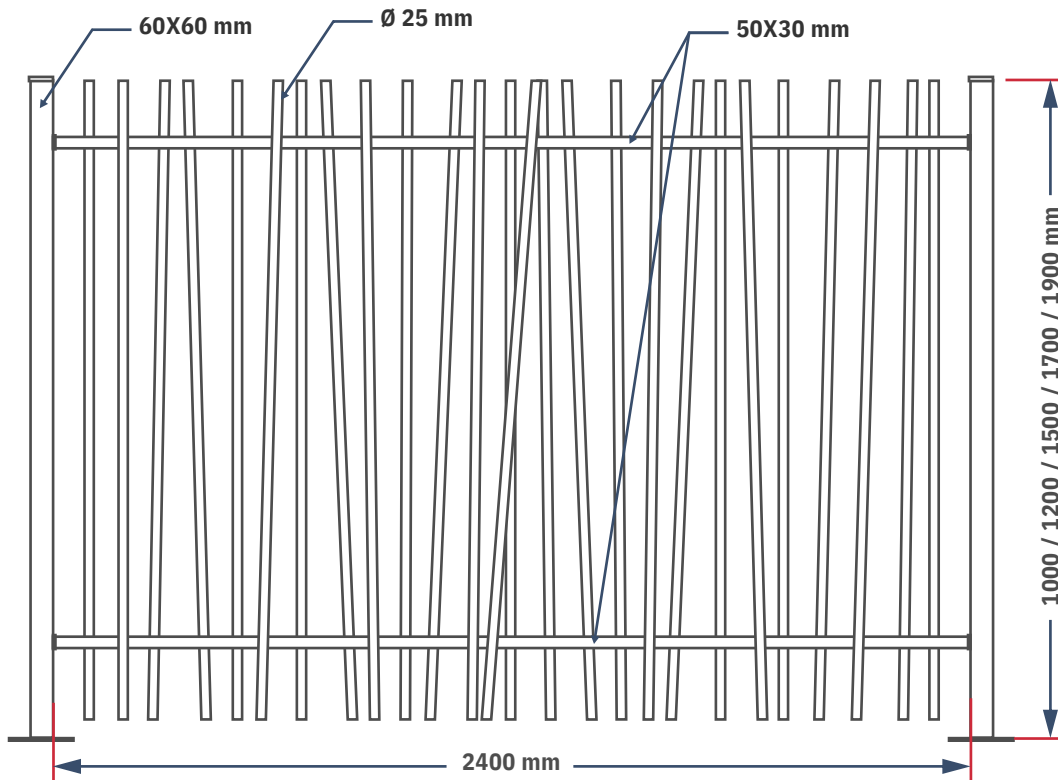

Height	1000 / 1200 / 1500 / 1700 / 1900
Width	mm 2400 mm
Top Rail	50 X 30 mm
Bottom Rail	50 X 30 mm
Vertical Bars	Ø 26 mm
Post	60 X 60 mm
Coating	Laminated on galvanized steel

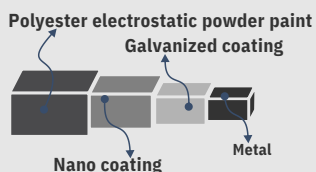

Coating Details

Color Options

Safe Spaces Surrounded by Quality



**Safe Spaces Surrounded by Quality**

# ASG MEDIUM SINGLE LEAF GATE

The “ASG Medium Single Leaf Gate” is an aesthetic and durable gate system that provides an ideal security solution for narrow spaces. With its modern design and robust structure, it offers a wide range of applications. It can be easily installed in security-sensitive areas such as industrial zones, residential properties, parks, gardens, and commercial premises.

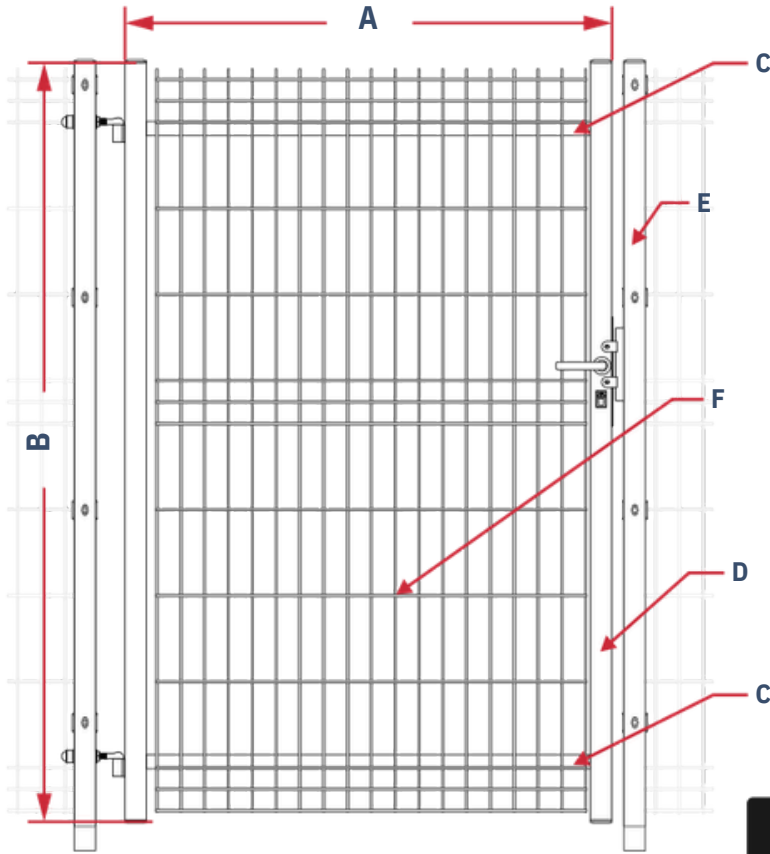

<b>A</b>	<b>Width</b>	1000 mm
<b>B</b>	<b>Height</b>	1000 / 1200 / 1500 / 1700 / 2000 mm
<b>C</b>	<b>Rails</b>	30 X 20 X 1,5 mm
<b>D</b>	<b>Leaf Profiles</b>	40 X 40 X 1,5 mm
<b>E</b>	<b>Post Profile</b>	80 X 80 X 2 mm
<b>F</b>	<b>Panel</b>	4 mm wire thickness with 55x200 mm mesh openings
	<b>Coating</b>	Laminated over galvanized steel



Industrial Lock



Standard Hinge

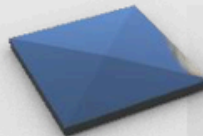

Plastic Cap

**Safe Spaces Surrounded by Quality**



**Safe Spaces Surrounded by Quality**

# ASG MEDIUM DOUBLE LEAF GATE

The "ASG Medium Double Leaf Gate" is an anaesthetic and durable gate system that offers an ideal security solution for confined spaces. Its modern design and robust construction make it suitable for a wide range of applications. It can be easily installed in security-sensitive areas such as industrial zones, residential properties, parks, gardens, and commercial premises.

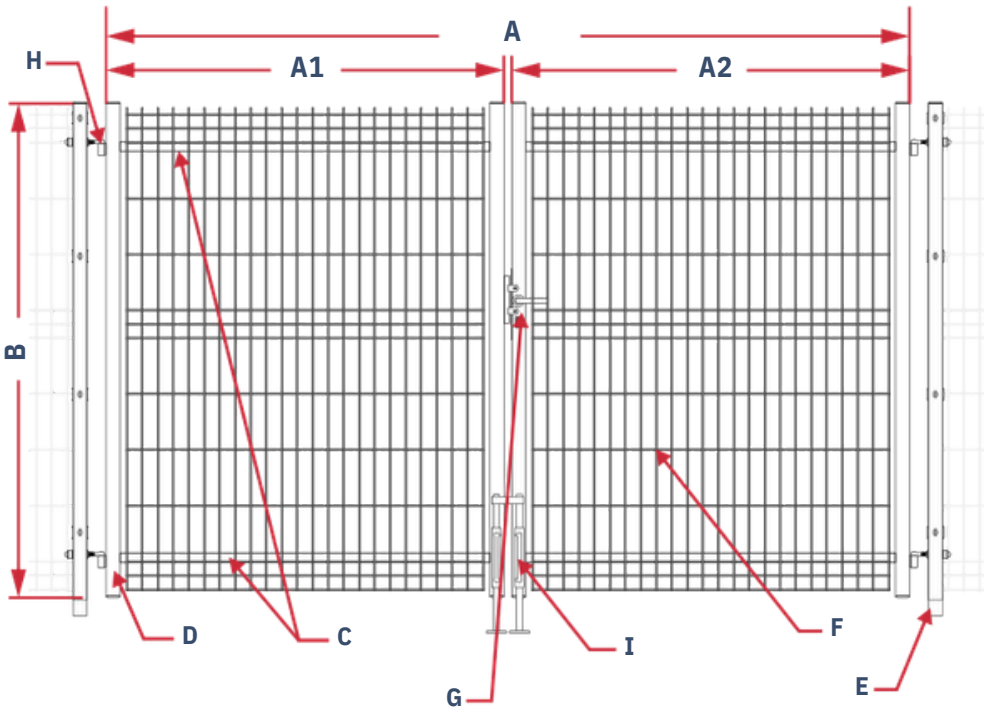

<b>A</b>	<b>Width</b>	2000 mm .....6000 mm
<b>B</b>	<b>Height</b>	1000 / 1200 / 1500 / 1700 / 2000 mm
<b>C</b>	<b>Rails</b>	30 X 20 X 1,5 mm
<b>D</b>	<b>Leaf Profiles</b>	40 X 40 X 1,5 mm
<b>E</b>	<b>Post Profile</b>	60 X 60 X 2 mm
<b>F</b>	<b>Panel</b>	4 mm wire thickness with 55x200 mm mesh spacing
<b>G</b>	<b>Gate Lock</b>	Industrial lock
<b>H</b>	<b>Hinge</b>	Standard hinge
<b>I</b>	<b>Fixation</b>	LOCINOX drop bolt with ground stop
	<b>Coating</b>	Laminated over galvanized steel

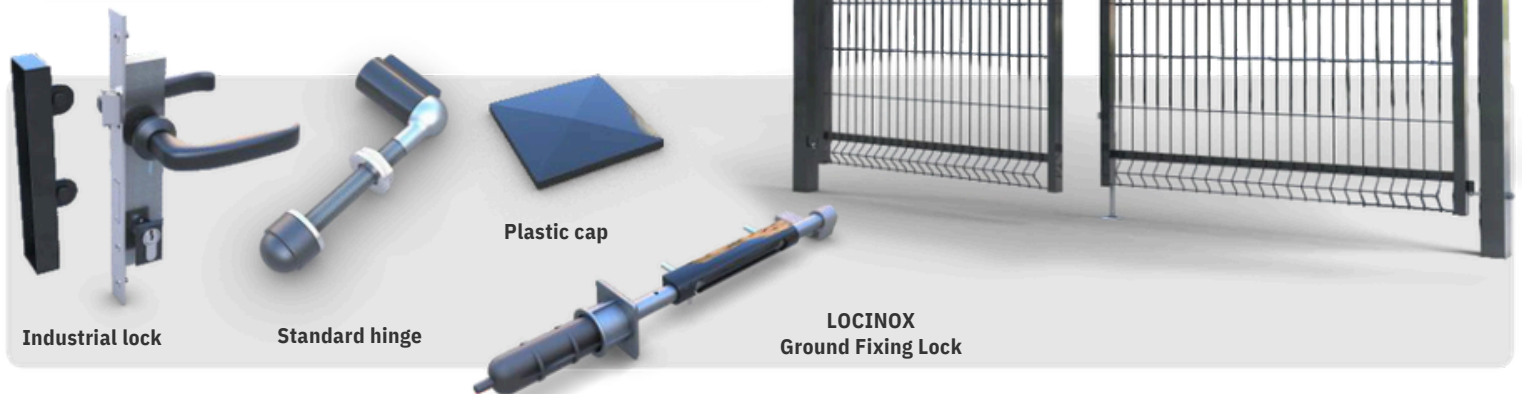

**Safe Spaces Surrounded by Quality**



**Safe Spaces Surrounded by Quality**

# ASG PRO SINGLE LEAF GATE

The “ASG Pro Single Leaf Gate” is an aesthetic and durable gate system that offers an ideal security solution for confined spaces. Its modern design and robust construction make it suitable for a wide range of applications. It can be easily installed in security-sensitive areas such as industrial zones, residential properties, parks, gardens, and commercial premises.

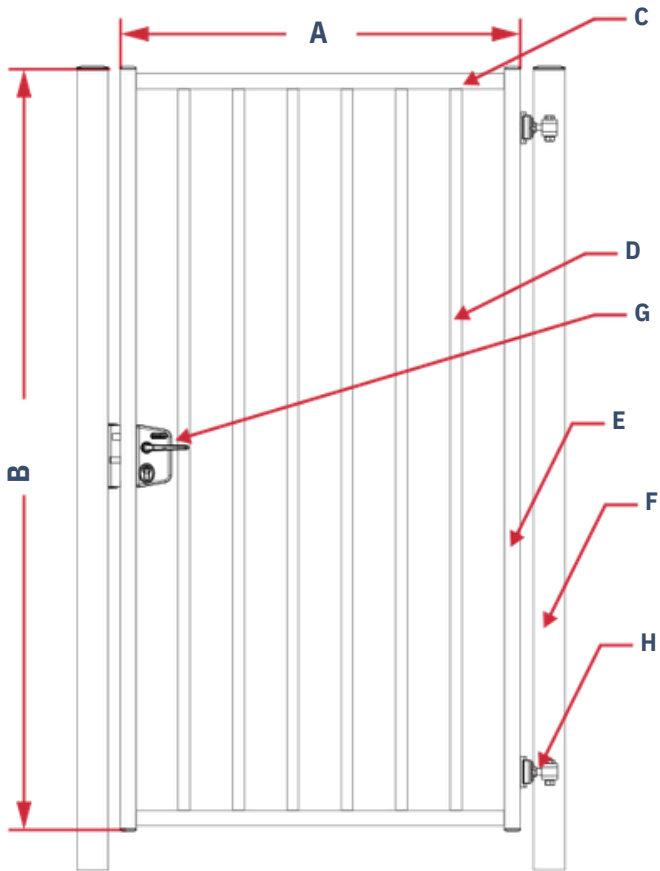

<b>A</b>	<b>Width</b>	1000 / 1200 / 1500 / 2000 mm
<b>B</b>	<b>Height</b>	1000 / 1200 / 1500 / 1700 / 1900 / 2000
<b>C</b>	<b>Rails</b>	mm 40 X 30 X 2 mm
<b>D</b>	<b>Vertical Bars</b>	30 X 20 X 1,5 mm
<b>E</b>	<b>Leaf Profiles</b>	40 X 40 X 2 mm
<b>F</b>	<b>Post Profile</b>	80 X 80 X 2 mm
<b>G</b>	<b>Gate Lock</b>	Locinox
<b>H</b>	<b>Hinge</b>	Locinox
	<b>Coating</b>	Laminated over galvanized steel

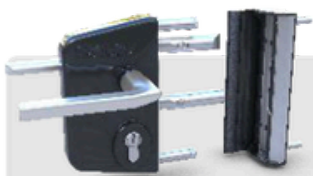

Locinox industrial lock

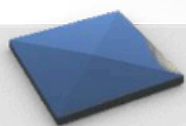

Plastic cap



Locinox hinge

Safe Spaces Surrounded by Quality



**Safe Spaces Surrounded by Quality**

# ASG PRO DOUBLE LEAF GATE

The “ASG ProDouble Wing Door” is an aesthetic and durable door system that offers an ideal security solution for narrow spaces. It is suitable for a wide range of uses thanks to its modern design and robust structure. It can be easily installed in areas sensitive to security such as industrial areas, residences, parks, gardens and commercial areas.

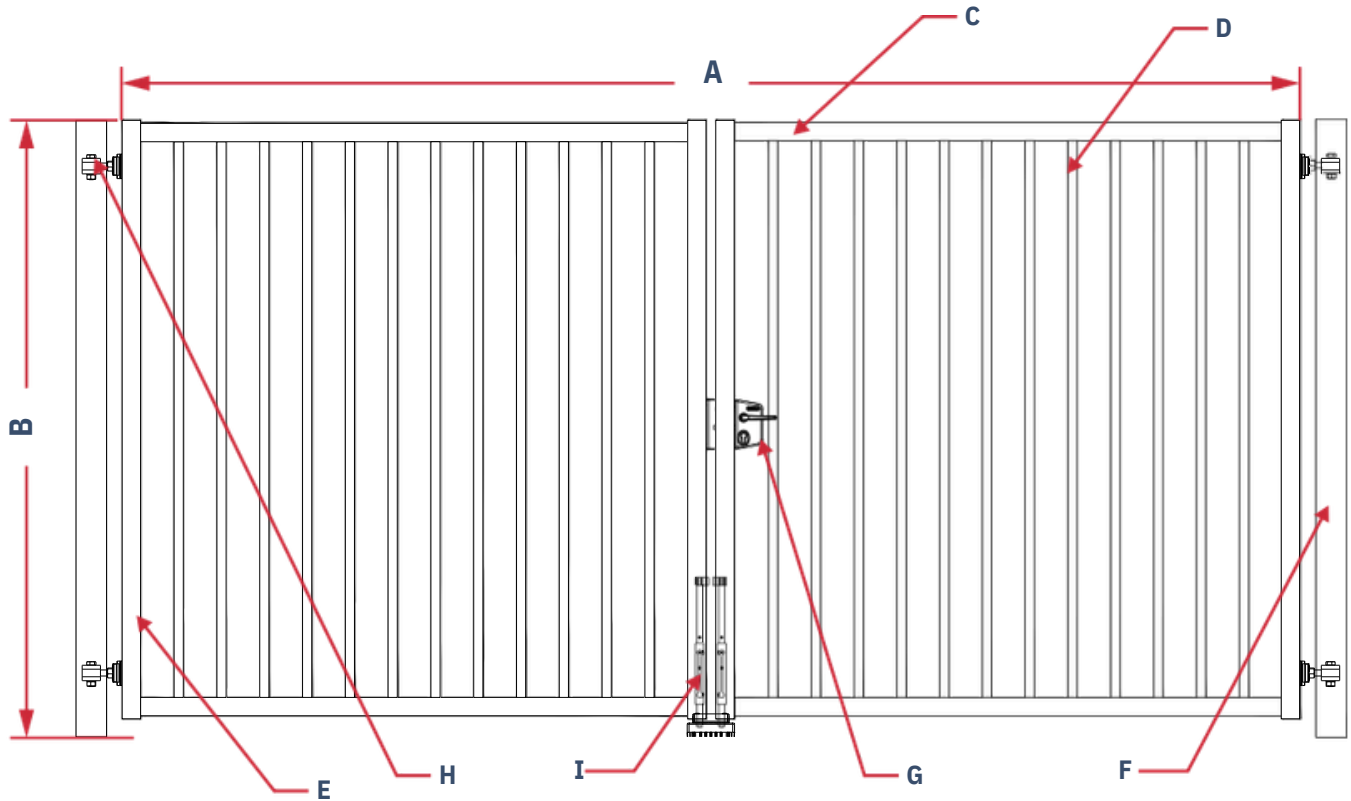

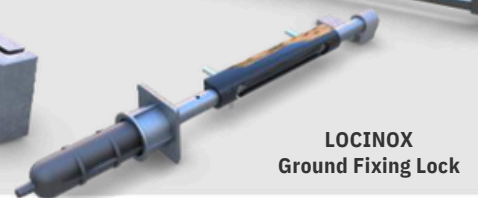
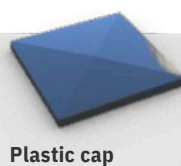
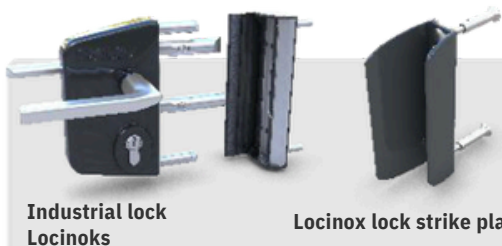

<b>A</b>	<b>Width</b>	2000 / ..... / 6000 mm
<b>B</b>	<b>Height</b>	1000 / 1200 / 1500 / 1700 / 1900 / 2000 mm
<b>C</b>	<b>Rails</b>	40 X 30 X 2 mm
<b>D</b>	<b>Vertical Bars</b>	30 X 20 X 1,5 mm
<b>E</b>	<b>Leaf Profiles</b>	40 X 40 X 2 mm
<b>F</b>	<b>Post Profile</b>	100 X 100 X 3 mm / 120 X 120 X 3 mm
<b>G</b>	<b>Gate Lock</b>	Locinox Industrial lock
<b>H</b>	<b>Hinge</b>	Locinox
<b>I</b>	<b>Fixation</b>	LOCINOX drop bolt with ground stop
	<b>Coating</b>	Laminated over galvanized steel







**Safe Spaces Surrounded by Quality**







# ACCESSORIES



	Model	Plastic ProfileCap
	Description	50x50 / 60x60
	Color	



	Model	Plastic Pipe Cap
	Description	Ø 48 / Ø51 / Ø60 / Ø 76
	Color	



	Model	Arrow Type Plastic Cap
	Description	50x50 / 60x60
	Color	



	Model	Plastic Profile Cap
	Description	40x40
	Color	



	Model	Aluminium Profile Cap
	Description	40x60
	Color	

	Model	Metal Profile Cap
	Description	Ø 48 / Ø51 / Ø60 / Ø 76
	Color	



	Model	Plastic Clip
	Description	Standart
	Color	

	Model	Deco Post Plastic Cover
	Description	Standart
	Color	

	Model	Spider Type Metal Cap
	Description	Standart
	Color	



	Model	Double Plastic Clip
	Description	For 40x60 mm RHS
	Color	



	Model	Double Metal Clip
	Description	SS 304 Stainless Steel
	Color	-



	Model	Self Drilling Screw
	Description	5,5x25 mm DIN 7504K
	Color	



	Model	Hexagon Socket Button Head Bolt
	Description	M8 x 35 / DIN 7380
	Color	SS 304 Stainless Steel



	Model	River Nut
	Description	M8 Hexagonal
	Color	Galvanised



	Model	Metal Pipe Clamp
	Description	Ø 48 / Ø51 / Ø60 / Ø 76
	Color	



	Model	Metal Profile Clamp
	Description	50x50 / 60x60 / 80x80
	Color	

	Model	End Cap
	Description	Ø 42 / Ø48
	Color	

	Model	Steel Dowel
	Description	M10 x 80 M10 x 100
	Color	

	Model	AK Type Hinge Set
	Description	Standart
	Color	

	Model	DM Type Hinge Set
	Description	Standart
	Color	

	Model	Locinox Type Hinge Set
	Description	Standart
	Color	

	Model	Mortise Lock
	Description	Standart
	Color	Standart

	Model	Cylinder for Mortise Lock
	Description	Standart
	Color	Standart

	Model	Gate Handle
	Description	Standart
	Color	SS 304 Stainless Steel

	Model	Gate Handle
	Description	Standart
	Color	SS 304 Stainless Steel

	Model	Locinox Type Lock Set
	Description	Standart
	Color	Standart

	Model	Drop Bolt Lock
	Description	Standart
	Color	Galvanised



**ASGFENCE**

[www.asgfence.com](http://www.asgfence.com)

Soğanlık Yeni Mahalle, Baltacı  
Mehmetpaşa Sokak, No:4A,  
Kartal, İstanbul, Türkiye

[info@asgfence.com](mailto:info@asgfence.com)

+90 850 202 0 ASG

**Safe Spaces Surrounded by Quality**